

Toi Toi Kids®

art.: 118 40 328

FAY: Shelf

12-02-2024

BG ИНСТРУКЦИИ ЗА СГЛОБЯВАНЕ
CS MONTÁŽNÍ NÁVOD
DA MONTERINGSINSTRUKTIONER
DE MONTAGEANLEITUNGEN
EL ΟΔΗΓΙΕΣ ΣΥΝΑΡΜΟΛΟΓΗΣΗΣ
EN ASSEMBLY INSTRUCTIONS
ES INSTRUCCIONES DE MONTAJE

ET KOKKUVÕTMISJUHISED
FI KOKOAMISOHJEET
FR NOTICE DE MONTAGE
GA IONSTRAIMÍ TIONÓL
HR UPUTE ZA MONTAŽU
HU ÖSSZESZERELÉSI ÚTMUTATÓ
IS LEIÐBEININGAR



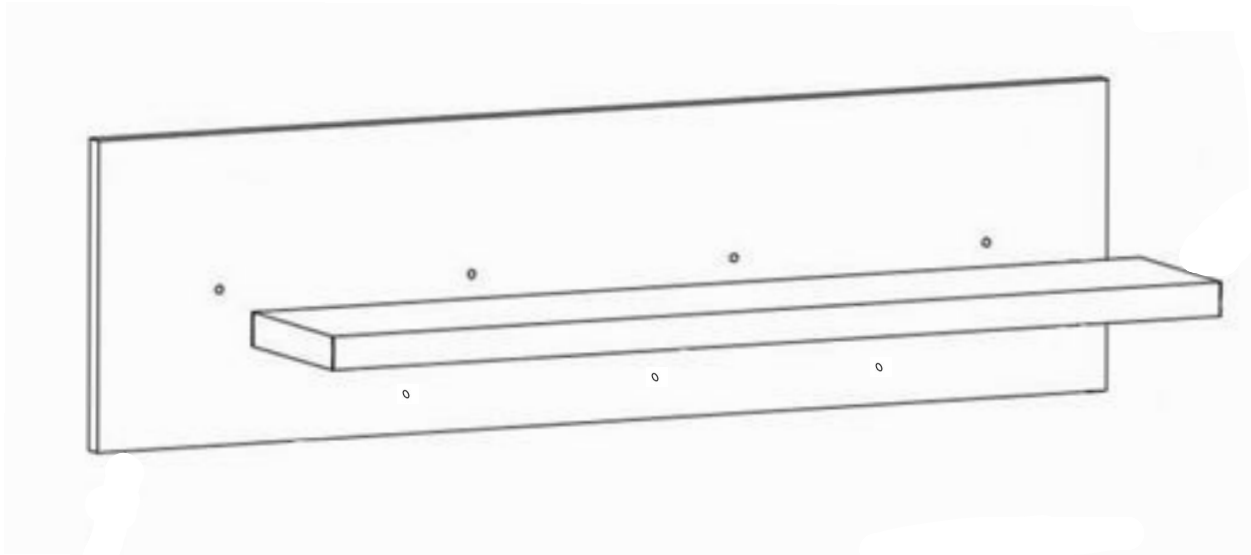
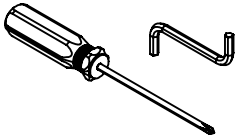

IT ISTRUZIONI DI MONTAGGIO
LT SURINKIMO INSTRUKCIJA
LV MONTĀŽAS NORĀDĪJUMI
MK/SL УПАТСТВО ЗА СОБРАНИЕ
MT STRUZZJONIJIET TA 'ASSEMBLEA
NL MONTAGE HANDLEIDING
NO MONTERINGSINSTRUKSJONER

PL INSTRUKCJE SKŁADANIA
PT INSTRUÇÕES DE MONTAGEM
RO INSTRUȚIUNI DE ASAMBLARE
SK MONTÁŽNE POKYNY
SL NAVODILA ZA MONTAŽO
SR УПУТСТВО ЗА МОНТИРАЊЕ
SV MONTERINGSANVISNINGAR
TR MONTAJ TALİMATLARI

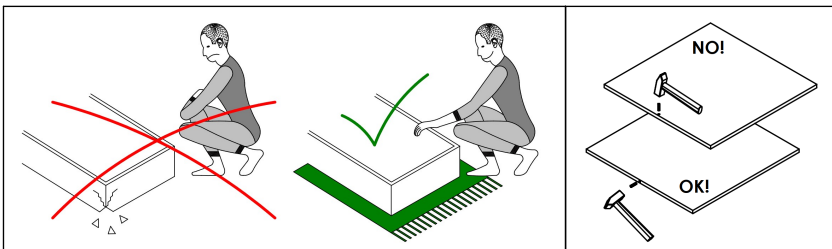

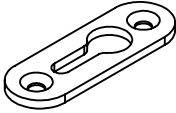
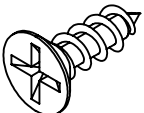
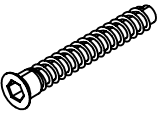
20 min.



| | | | | | |
|---|---|---|---|--|--|
|  | 3x13  | 7x50  |  |  |  |
| A x 2 | B x 4 | C x 4 | D x 3 | E x 3 | IMBUS |

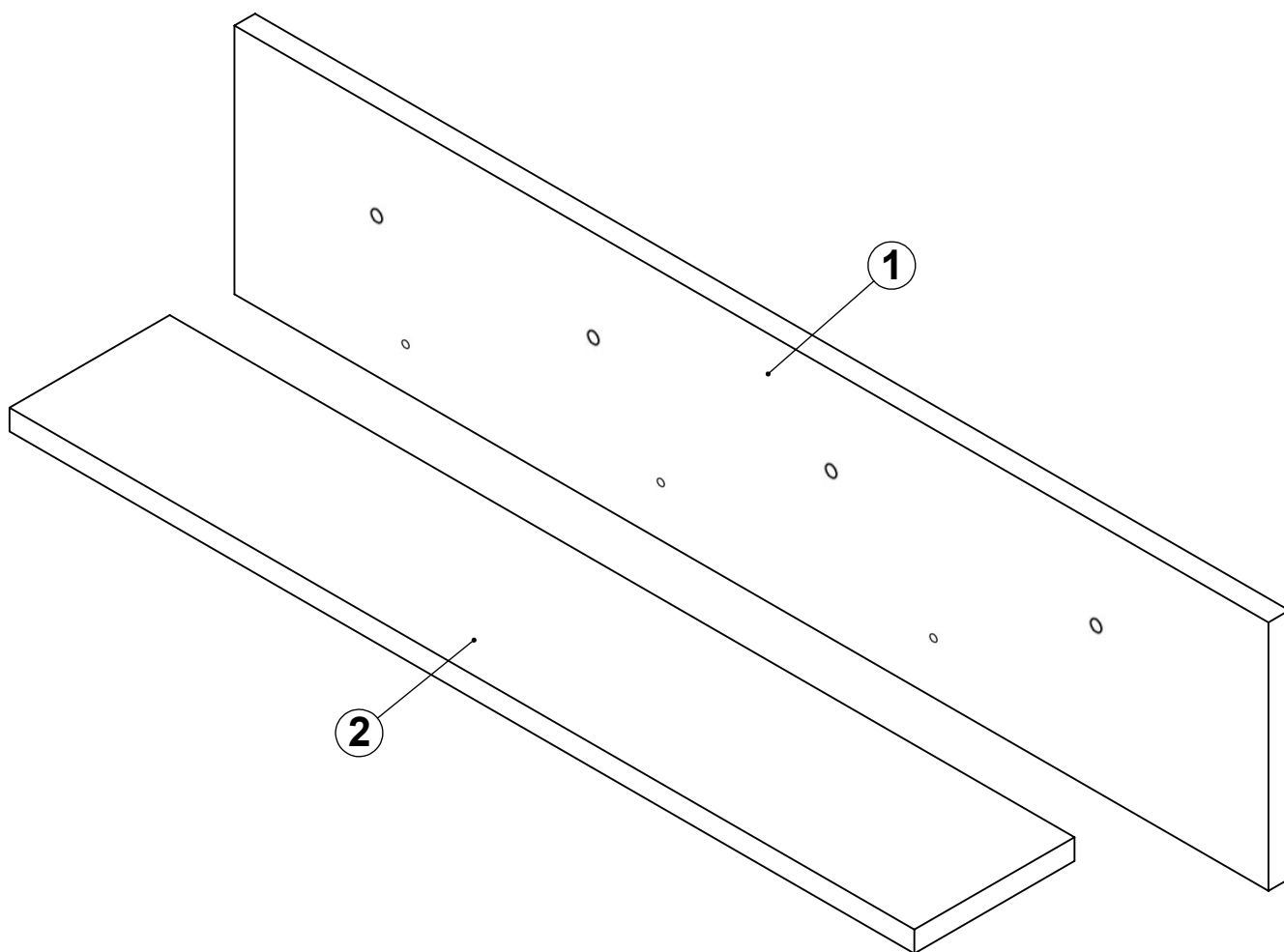

STEP - 1

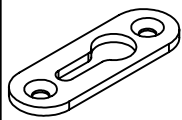

Ax2

3x13

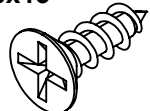

Bx4

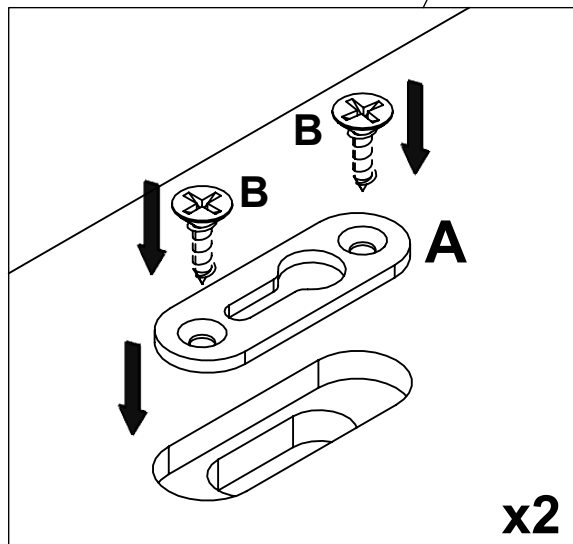
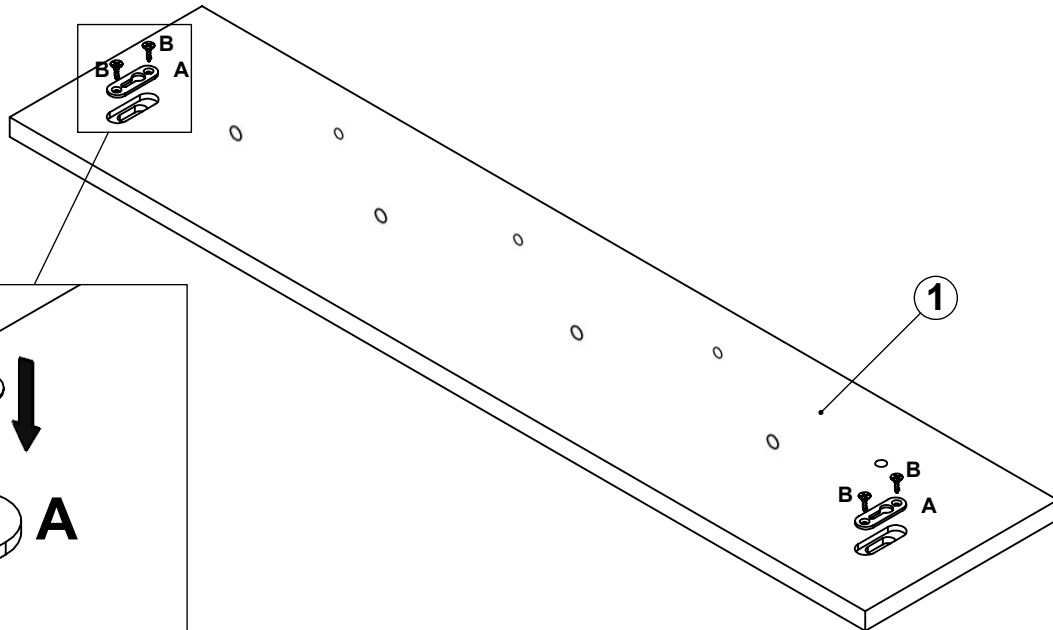
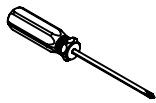

STEP - 2

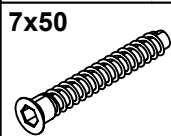

7x50

Cx4



Dx3



Ex3

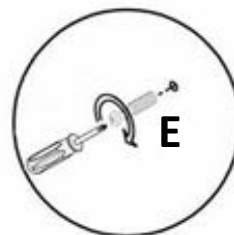
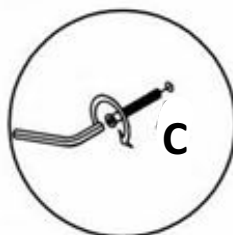
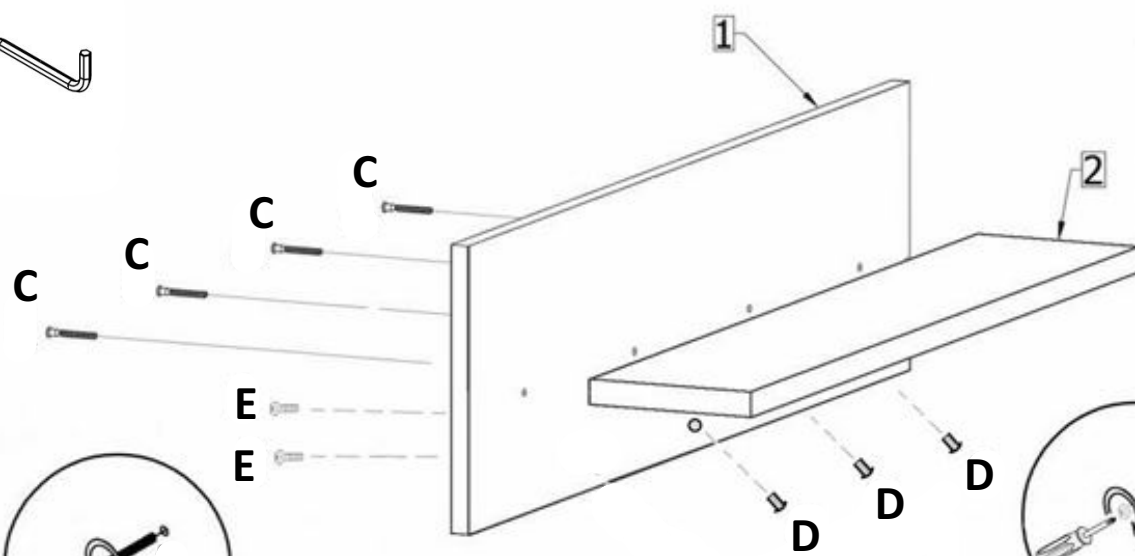
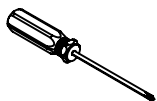

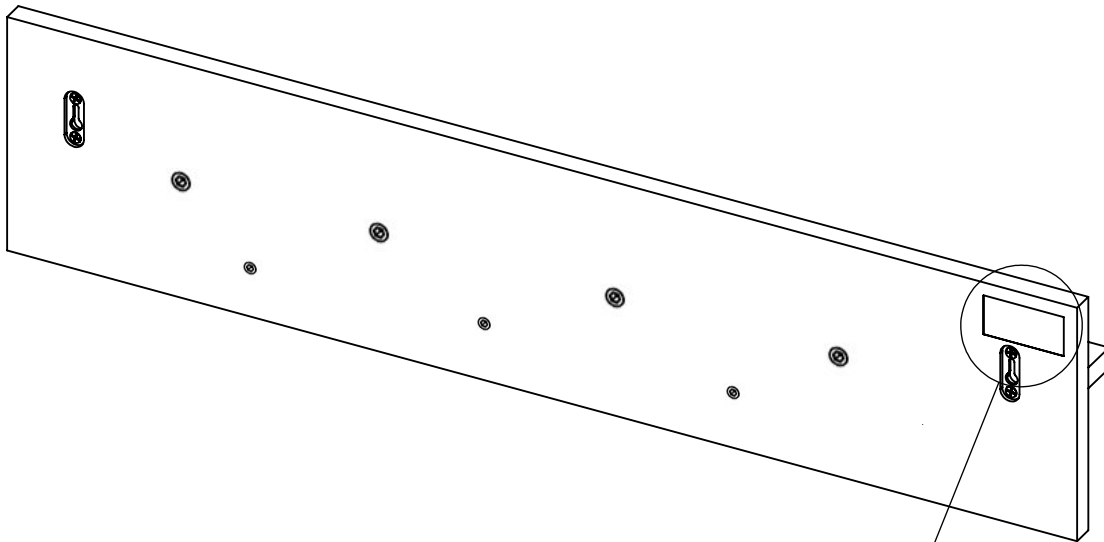

QC-CODE

(UK) for service requests

(NL) voor service vragen

(FR) pour les demandes de service

(DE) für Service Anfragen

(ES) para consultas de servicio

(IT) per richieste di assistenza

